

Fittings for Butt Fusion

35 01 87

Bend 90°, PN 16, PVDF-Standard

K

- * new model with compact design and optimized flow values

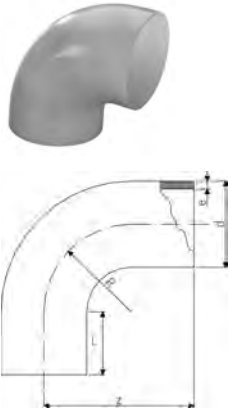

PF 2 35 190

d [mm]	PN	Code	kg	e [mm]	L [mm]	z [mm]	R [mm]
*20	16	735 018 706	0.015	1.9	23	38	15
*25	16	735 018 707	0.021	1.9	23	42	19
*32	16	735 018 708	0.035	2.4	22	46	24
*40	16	735 018 709	0.050	2.4	21	51	30
*50	16	735 018 710	0.087	3.0	21	58	37
*63	16	735 018 711	0.128	3.0	21	66	45
75	16	735 018 712	0.243	3.6	23	75	62
90	16	735 018 713	0.385	4.3	23	90	77
110	16	735 018 714	0.643	5.3	23	110	98
140	16	735 018 716	1.423	6.7	33	140	121
160	16	735 018 717	2.052	7.7	33	160	141
200	16	735 018 719	3.798	9.6	33	200	181
225	16	735 018 720	5.274	10.8	33	220	200

35 01 85

Bend 90°, PN 10, PVDF-Standard

K

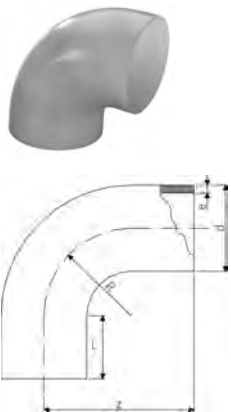

PF 2 35 190

d [mm]	PN	Code	kg	e [mm]	L [mm]	z [mm]	R [mm]
90	10	735 018 513	0.294	2.8	23	90	77
110	10	735 018 514	0.578	3.4	23	110	98
125	10	735 018 515	0.670	3.9	28	125	112
140	10	735 018 516	0.970	4.3	33	140	121
160	10	735 018 517	1.440	4.9	33	160	141
200	10	735 018 519	2.730	6.2	33	200	181
225	10	735 018 520	3.900	6.9	33	220	200

35 10 86

Elbow 90°, PN 16, PVDF-Standard

K



PF 2 35 190

d [mm]	PN	Code	kg	e [mm]	L [mm]	L1 [mm]
20	16	735 108 606	0.017	1.9	38	25
25	16	735 108 607	0.023	1.9	42	26
32	16	735 108 608	0.040	2.4	46	26
40	16	735 108 609	0.060	2.4	51	28
50	16	735 108 610	0.105	3.0	58	28
63	16	735 108 611	0.180	3.0	66	28

35 15 86

Elbow 45°, PN 16, PVDF-Standard**K**

PF 2 35 190

d [mm]	PN	Code	kg	e [mm]	L [mm]	L1 [mm]
20	16	735 158 606	0.014	1.9	32	25
25	16	735 158 607	0.019	1.9	34	26
32	16	735 158 608	0.033	2.4	36	26
40	16	735 158 609	0.048	2.4	39	28
50	16	735 158 610	0.079	3.0	42	30
63	16	735 158 611	0.116	3.0	47	31
75	16	735 158 612	0.160	3.6	49	32
90	16	735 158 613	0.260	4.3	57	37
110	16	735 158 614	0.480	5.3	70	46
140	16	735 158 616	1.000	6.7	88	57
160	16	735 158 617	1.470	7.7	100	62
200	16	735 158 619	2.800	9.6	124	77
225	16	735 158 620	4.000	10.8	140	88

35 15 85

Elbows 45°; PN 10, PVDF-Standard**K**

PF 2 35 190

d [mm]	PN	Code	kg	e [mm]	L [mm]	L1 [mm]
90	10	735 158 513	0.181	2.8	57	37
110	10	735 158 514	0.330	3.4	70	46
125	10	735 158 515	0.490	3.9	79	51
140	10	735 158 516	0.680	4.3	88	57
160	10	735 158 517	0.990	4.9	100	62
200	10	735 158 519	1.940	6.2	124	77
225	10	735 158 520	2.780	6.9	140	88

35 20 86

T 90° equal, PN 16, PVDF-Standard**K**

PF 2 35 190

d [mm]	PN	Code	kg	e [mm]	L [mm]	L1 [mm]
20	16	735 208 606	0.023	1.9	38	25
25	16	735 208 607	0.032	1.9	42	27
32	16	735 208 608	0.056	2.4	46	27
40	16	735 208 609	0.083	2.4	51	28
50	16	735 208 610	0.140	3.0	58	28
63	16	735 208 611	0.231	3.0	66	28
75	16	735 208 612	0.370	3.6	75	32
90	16	735 208 613	0.660	4.3	90	39
110	16	735 208 614	1.210	5.3	110	48
140	16	735 208 616	2.600	6.7	140	62
160	16	735 208 617	3.500	7.7	160	71
200	16	735 208 619	7.500	9.6	200	80
225	16	735 208 620	10.600	10.8	220	86

35 20 85

T 90° equal, PN 10, PVDF-Standard**K**

PF 2 35 190

d [mm]	PN	Code	kg	e [mm]	L [mm]	L1 [mm]
90	10	735 208 513	0.397	2.8	90	39
110	10	735 208 514	0.714	3.4	110	48
125	10	735 208 515	1.280	3.9	125	56
140	10	735 208 516	1.780	4.3	140	62
160	10	735 208 517	2.570	4.9	160	71
200	10	735 208 519	4.297	6.2	200	80
225	10	735 208 520	7.250	6.9	220	86

35 20 86

T 90° reduced, PN 16, PVDF-Standard

K



PF 2 35 426

d - d1 [mm]	PN	Code	kg	e [mm]	e1 [mm]	L [mm]	L1 [mm]	L2 [mm]	L3 [mm]
160 - 90	16	735 208 662	3.200	7.7	4.3	155	130	60	25
160 - 110	16	735 208 661	3.300	7.7	5.3	155	130	60	25
225 - 90	16	735 208 670	6.000	10.8	4.3	155	160	60	25
225 - 110	16	735 208 669	6.100	10.8	5.3	155	160	60	25

35 20 85

T 90° reduced, PN 10, PVDF-Standard

K

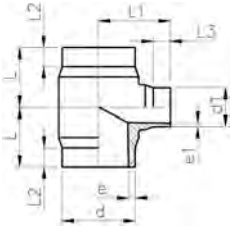

PF 2 35 426

d - d1 [mm]	PN	Code	kg	e [mm]	e1 [mm]	L [mm]	L1 [mm]	L2 [mm]	L3 [mm]
160 - 90	10	735 208 562	2.300	4.9	4.3	155	130	60	25
160 - 110	10	735 208 561	2.300	4.9	5.3	155	130	60	25
225 - 90	10	735 208 570	4.400	6.9	4.3	155	160	60	25
225 - 110	10	735 208 569	4.400	6.9	5.3	155	160	60	25

35 91 88

Instrument Installation Fitting, PN 16, PVDF-HP**K****Model:**

- Suitable for hole diameters from 1/4 - 3/4
- Injection-moulded version

Note:

- Hole needs to be milled, HAND HELD DRILLING MUST NOT BE DONE

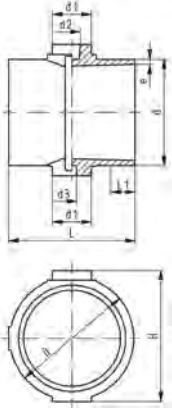

PF 2 37 425

d [mm]	PN	Code	kg	D [mm]	e [mm]	d1 [mm]	d2 [mm]	H [mm]	L [mm]	L1 [mm]	L1 [mm]
63	16	735 918 811	0.235	85	3.0	40	17	89	120	25	25
75	16	735 918 812	0.326	96	3.6	40	17	101	130	25	25
90	16	735 918 813	0.418	110	4.3	40	17	116	130	25	25
110	16	735 918 814	0.561	127	5.3	40	17	136	130	25	25

35 91 86

Instrument Installation Fitting, PN 16, PVDF-HP**K****Model:**

- Suitable for hole diameters from 1/8 - 3/4
- Machined version

Note:

- Hole needs to be milled, HAND HELD DRILLING MUST NOT BE DONE

* no stock item

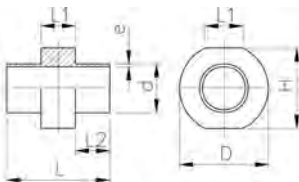

PF 2 37 425

d [mm]	PN	Code	kg	D [mm]	e [mm]	H [mm]	L [mm]	L1 [mm]	L2 [mm]
*63	16	735 918 611	0.495	105	3.0	97	100	40	27
*75	16	735 918 612	0.554	115	3.6	108	90	40	22
*90	16	735 918 613	0.649	128	4.3	121	90	40	22
*110	16	735 918 614	0.778	145	5.3	139	90	40	22
*125	16	735 918 615	1.007	162	6.0	157	100	40	27
*140	16	735 918 616	1.185	176	6.7	171	110	40	32
*160	16	735 918 617	1.405	194	7.7	190	110	40	32
*200	16	735 918 619	1.871	231	9.6	228	110	40	32
*225	16	735 918 620	2.284	254	10.8	251	110	40	32

35 91 85

Instrument Installation Fitting, PN 10, PVDF-HP**K****Model:**

- Suitable for hole diameters from 1/8 - 3/4
- Machined version

Note:

- Hole needs to be milled, HAND HELD DRILLING MUST NOT BE DONE

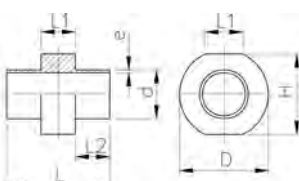

PF 2 37 425

d [mm]	PN	Code	kg	D [mm]	e [mm]	H [mm]	L [mm]	L1 [mm]	L2 [mm]
125	10	735 918 565	0.858	162	3.9	157	100	40	27
140	10	735 918 566	1.003	176	4.4	171	110	40	32
160	10	735 918 567	1.151	194	4.9	190	110	40	32
200	10	735 918 569	1.486	231	6.2	228	110	40	32
225	10	735 918 570	3.151	254	7.0	251	110	40	32

SYGEF® Standard Sensor Connection Tee

The maximal solution
for a minimal dead leg



Your benefit with the Sensor Connection Tee:

- Easier cleaning (CIP)
- Minimal Biofilm building up
- Reduced installation costs
- Compact design
- Reliable sensor connection
- Fulfills FDA and USP class VI

All available standards:

- ISO 1127
- DIN 32676
- ASME BPE
- MM
- 3A
- ISO 2852
- BS 4825 Metric & Inch
- DIN 3017
- JIS G3447
- SYGEF-Plus

The SCT at a glance:

- Main line sizes d20 to d110 compatible with IR-Plus® & BCF®Plus fusion
- PN16 welding dimension (PN10 for d90 & d110 also available)
- Clamp connection up from d20 to d75 depending on main line dimension
- Fully customised solution, to suit your application

→ Please contact GF for further technical information

35 90 86

Reducer, PN 16, PVDF-Standard

K

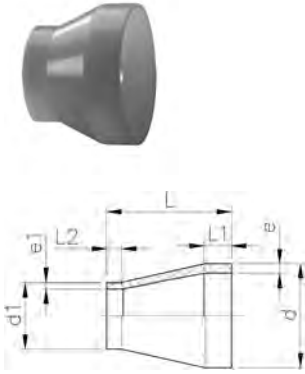

d - d1 [mm]	PN	Code	kg	e [mm]	e1 [mm]	L [mm]	L1 [mm]	L2 [mm]
25 - 20	16	735 908 637	0.012	1.9	1.9	50	22	22
32 - 20	16	735 908 642	0.017	2.4	1.9	50	22	22
32 - 25	16	735 908 641	0.018	2.4	1.9	50	22	22
40 - 20	16	735 908 648	0.024	2.4	1.9	58	22	24
40 - 25	16	735 908 647	0.025	2.4	1.9	55	22	24
40 - 32	16	735 908 646	0.029	2.4	2.4	55	22	24
50 - 25	16	735 908 654	0.031	3.0	1.9	60	22	25
50 - 32	16	735 908 653	0.038	3.0	2.4	60	22	25
50 - 40	16	735 908 652	0.040	3.0	2.4	60	22	25
63 - 32	16	735 908 660	0.050	3.0	2.4	65	22	25
63 - 40	16	735 908 659	0.052	3.0	2.4	65	22	25
63 - 50	16	735 908 658	0.060	3.0	3.0	65	22	25
75 - 40	16	735 908 666	0.069	3.6	2.4	68	24	25
75 - 50	16	735 908 665	0.078	3.6	3.0	65	24	25
75 - 63	16	735 908 664	0.080	3.6	3.0	65	24	25
90 - 63	16	735 908 671	0.120	4.3	3.0	75	25	30
90 - 75	16	735 908 670	0.130	4.3	3.6	75	25	35
110 - 63	16	735 908 678	0.225	5.3	3.0	90	30	30
110 - 75	16	735 908 677	0.213	5.3	3.6	90	30	35
110 - 90	16	735 908 676	0.230	5.3	4.3	90	30	35
140 - 110	16	735 908 685	0.450	6.7	5.3	110	40	40
160 - 110	16	735 908 690	0.650	10.8	9.6	160	55	50
160 - 140	16	735 908 688	0.450	7.7	5.3	120	40	40
200 - 160	16	735 908 692	1.340	7.7	6.7	120	40	35
225 - 110	16	735 908 695	1.540	10.8	5.3	160	50	40
225 - 160	16	735 908 696	1.730	10.8	5.3	160	50	40
225 - 200	16	735 908 697	1.980	10.8	7.7	160	55	28

PF 2 35 190

35 90 85

Reducer, PN 10, PVDF-Standard

K



d - d1 [mm]	PN [bar]	Code	kg	e [mm]	e1 [mm]	L [mm]	L1 [mm]	L2 [mm]
90 - 63	10 / 16	735 908 551	0.102	2.8	3.0	75	25	30
110 - 63	10 / 16	735 908 553	0.164	3.4	3.0	90	30	30
110 - 90	10 / 10	735 908 555	0.167	3.4	2.8	90	30	35
125 - 110	10 / 16	735 908 580	0.270	3.9	5.3	100	35	40
140 - 110	10 / 16	735 908 585	0.385	4.3	5.3	110	40	40
140 - 125	10 / 10	735 908 584	0.340	4.3	3.9	110	40	40
160 - 110	10 / 10	735 908 561	0.449	4.9	3.4	120	40	40
160 - 110	10 / 16	735 908 590	0.425	4.9	5.3	120	40	40
160 - 140	10 / 10	735 908 588	0.460	4.9	4.3	120	40	40
200 - 160	10 / 10	735 908 592	0.830	6.2	4.9	145	50	40
225 - 110	10 / 10	735 908 566	1.120	6.9	3.4	160	55	35
225 - 110	10 / 16	735 908 595	0.940	6.9	5.3	160	55	35
225 - 160	10 / 10	735 908 596	1.140	6.9	4.9	160	55	40
225 - 200	10 / 10	735 908 597	1.200	6.9	6.2	160	55	50

PF 2 35 190

Unions for Butt Fusion

35 52 86

Union (FPM black), PN 16, PVDF-Standard

K

Model:

- supplied with sealing
- d75, d90 and d110 with buttress shaped thread

Note:

- For the dimensions d75-110 please see instructions for the installation

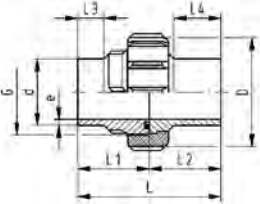

d [mm]	PN	Code	kg	D [mm]	e [mm]	L [mm]	L1 [mm]	L2 [mm]	L3 [mm]
20	16	735 528 606	0.081	45	1.9	107	53	53	25
25	16	735 528 607	0.123	55	1.9	112	56	56	25
32	16	735 528 608	0.167	62	2.4	119	59	59	25
40	16	735 528 609	0.269	75	2.4	125	62	63	25
50	16	735 528 610	0.370	84	3.0	130	65	66	25
63	16	735 528 611	0.592	101	3.0	136	68	69	25
75	16	735 528 612	0.740	133	3.6	131	66	66	24
90	16	735 528 613	0.730	133	4.3	131	66	65	24
110	16	735 528 614	1.020	155	5.3	131	66	65	25

PF 2 35 421

35 60 86

Union end, PN 16, PVDF-Standard

K

Model:

- Suitable for SYGEF® Standard Union Butt Fusion
- Suitable for Diaphragm Valve Type 314
- Suitable for Vortex Sensor

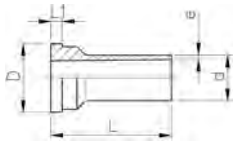

d [mm]	PN	Code	kg	D [mm]	e [mm]	L [mm]	L1 [mm]
20	16	735 608 606	0.020	30	1.9	53	5
25	16	735 608 607	0.029	39	1.9	56	5
32	16	735 608 608	0.041	45	2.4	59	6
40	16	735 608 609	0.069	57	2.4	63	6
50	16	735 608 610	0.094	63	3.0	66	7
63	16	735 608 611	0.144	78	3.0	69	8
75	16	735 608 612	0.188	101	3.6	66	9
90	16	735 608 613	0.184	101	4.3	65	9
110	16	735 608 614	0.260	121	5.3	65	10

PF 2 35 421

Blanking Union End

d [mm]	d [inch]	PN	DN [mm]	Code	SP	kg	A [mm]	B [mm]	C [inch]	D [mm]
20		232	0	175 482 101	-	0.007				
25		232	0	175 482 102	-	0.015	1	1	1	0
32		232	0	175 482 103	-	0.025	2	1	1	0
50		232	0	175 482 105	-	0.060				
63		232	0	175 482 106	-	0.110				

PF 2 65 434

24 60 06

Union Ends, Stainless Steel 1.4404 (316L)

Rp

A



Model:

- Parallel female thread Rp

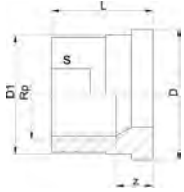

PF 2 30 153

Rp [inch]	PN	Code	SP	kg	z [mm]	D [mm]	D1 [mm]	L [mm]	s [mm]
3/8	16	724 600 655	-	0.030	9	24	22	19	19
1/2	16	724 600 656	-	0.060	11	30	28	24	24
3/4	16	724 600 657	-	0.100	11	39	36	26	29
1	16	724 600 658	-	0.140	12	45	42	29	36
1 1/4	16	724 600 659	-	0.230	14	57	53	33	45
1 1/2	16	724 600 660	-	0.320	15	63	59	34	54
2	16	724 600 661	-	0.450	15	78	74	39	63

24 60 07

Union Ends, Stainless Steel 1.4404 (316L)

R

A



Model:

- Taper male thread R

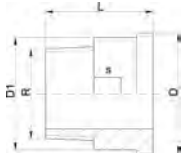

PF 2 30 153

R [inch]	PN	Code	SP	kg	D [mm]	D1 [mm]	L [mm]	s [mm]
3/8	16	724 600 705	-	0.050	24	22	30	19
1/2	16	724 600 706	-	0.090	30	28	34	24
3/4	16	724 600 707	-	0.120	39	36	36	32
1	16	724 600 708	-	0.190	45	42	40	37
1 1/4	16	724 600 709	-	0.350	57	53	46	48
1 1/2	16	724 600 710	-	0.400	63	59	48	54
2	16	724 600 711	-	0.660	78	74	55	69

24 60 55

Union Ends, Stainless Steel 1.4404 (316L)

Welding End

A

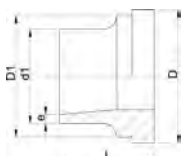

PF 2 30 153

d [mm]	d1 [mm]	PN	Code	SP	kg	D [mm]	D1 [mm]	L [mm]	e [mm]
16	17	16	724 605 505	-	0.030	24	22	18	1.6
20	21	16	724 605 506	-	0.050	30	28	22	2.0
25	26	16	724 605 507	-	0.080	39	36	23	2.0
32	33	16	724 605 508	-	0.110	45	42	26	2.0
40	42	16	724 605 509	-	0.190	57	53	26	2.0
50	48	16	724 605 510	-	0.220	63	59	28	2.0
63	60	16	724 605 511	-	0.370	78	74	32	2.6

35 69 04

Union nut, PN16, PVDF-Standard**J**

- d75, d90 and d110 with buttress shaped thread

Note:

- For the dimensions d75-110 please see instructions for the installation



PF 2 35 191

Socket Fusion d [mm]	Butt Fusion d [mm]	PN	Code	kg	D [mm]	G [inch]	L [mm]	
16	16	16	735 690 405	0.013	35	3/4	21	
20	20	16	735 690 406	0.023	45	1	22	
25	25	16	735 690 407	0.047	55	1 1/4	24	
32	32	16	735 690 408	0.048	62	1 1/2	26	
40	40	16	735 690 409	0.097	75	2	29	
50	50	16	735 690 410	0.146	84	2 1/4	33	
63	63	16	735 690 411	0.244	101	2 3/4	35	

24 69 01

Union nut stainless steel 1.4404 (316L)**A**

* Octagon union nut

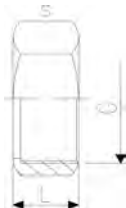

PF 2 30 153

d [mm]	PN	Code	SP	kg	L [mm]	G [inch]	s [mm]	
16	16	724 690 105	-	0.060	19	3/4	32	
20	16	724 690 106	-	0.110	21	1	41	
25	16	724 690 107	-	0.100	23	1 1/4	46	
32	16	724 690 108	-	0.170	24	1 1/2	55	
*40	16	724 690 109	-	0.240	27	2	68	
*50	16	724 690 110	-	0.300	31	2 1/4	74	
*63	16	724 690 111	-	0.390	35	2 3/4	88	

35 64 86

Union bush, PN 16, PVDF-Standard**K****Model:**

- Suitable for SYGEF® Standard Union Butt Fusion
- d75, d90 and d110 with buttress shaped thread

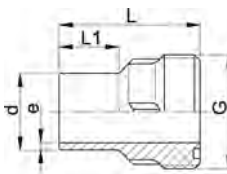

PF 2 35 421

d [mm]	PN	Code	kg	G [inch]	e [mm]	L [mm]	L1 [mm]	
20	16	735 648 606	0.029	1	1.9	53	25	
25	16	735 648 607	0.045	1 1/4	4.9	56	25	
32	16	735 648 608	0.063	1 1/2	2.4	59	25	
40	16	735 648 609	0.098	2	2.4	62	25	
50	16	735 648 610	0.124	2 1/4	3.0	65	25	
63	16	735 648 611	0.195	2 3/4	3.0	68	25	
75	16	735 648 612	0.272	S 107.5 x 3.6	3.6	66	24	
90	16	735 648 613	0.273	S 107.5 x 3.6	4.3	66	24	
110	16	735 648 614	0.364	S 127.5 x 3.6	5.3	66	25	

EPDM 48 41 00
FPM 49 41 00

O-Ring Gaskets

A

Model:

- For unions
- Hardness approx. 65° Shore
- EPDM minimum temperature -40°C
- FPM minimum temperature -15°C

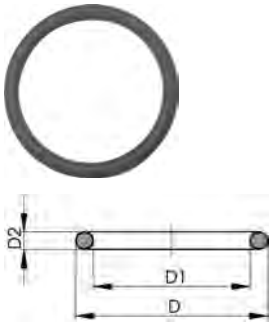

PF 2 30 162

d [mm]	DN [mm]	EPDM Code	FPM Code	SP	kg	D [mm]	D1 [mm]	D2 [mm]
10-12	8	748 410 004	749 410 004	-	0.002	18	12	3
16	10	748 410 005	749 410 005	-	0.002	21	16	3
20	15	748 410 006	749 410 006	-	0.002	27	20	4
25	20	748 410 007	749 410 007	100	0.002	35	28	4
32	25	748 410 008	749 410 008	100	0.002	40	33	4
40	32	748 410 009	749 410 009	-	0.006	51	41	5
50	40	748 410 010	749 410 010	-	0.007	58	47	5
63	50	748 410 011	749 410 011	100	0.010	70	60	5
75	65	748 410 014	749 410 014	100	0.012	93	82	5
90	80	748 410 015	749 410 015	100	0.015	112	101	5
110	100	748 410 016	749 410 016	50	0.031	134	120	7

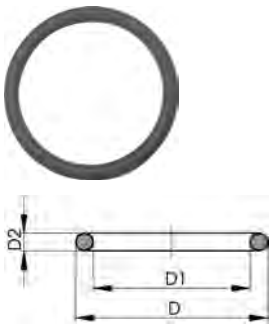

PF 2 3 0 1

O-Ring Gaskets

Model:

- For unions
- Hardness approx. 75° Shore
- FFPM minimum temperature -20°C

d [mm]	DN [mm]	FFPM Code	D [mm]	D1 [mm]	D2 [mm]
20	15	700 245 481	27	20	4
25	20	700 245 482	35	28	4
32	25	700 245 483	40	33	4
40	32	700 245 484	51	41	5
50	40	700 245 485	58	47	5
63	50	700 245 486	70	60	5

Transition Fittings for Butt Fusion

35 91 05

Adaptor Nipple, male thread - R, PN 16, PVDF-Standard **K**

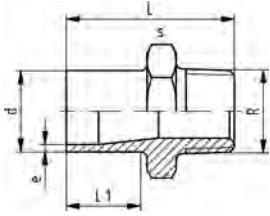

PF 2 35 421

Model:

- With butt fusion spigot and BSP tapered male thread
- Connection to plastic thread only
- Do not use thread sealing pastes that are harmful to PVDF
- Avoid stresses when installing and large changes in temperature

d [mm]	R [inch]	PN	Code	kg	e [mm]	L [mm]	s [mm]	L1 [mm]
20	3/8	16	735 910 555	0.023	1.9	50	32	26
20	3/8	16	735 910 556	0.025	1.9	53	32	26
25	3/4	16	735 910 557	0.032	1.9	55	36	26
32	1	16	735 910 558	0.051	2.4	57	46	26
40	1 1/4	16	735 910 559	0.075	2.4	60	55	26
50	1 1/2	16	735 910 560	0.112	3.0	63	65	26
63	2	16	735 910 561	0.179	3.0	69	75	27

35 91 45

Adaptor Nipple, male thread - NPT, PN 16, PVDF-Standard **K**

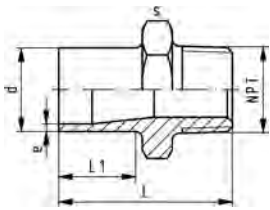

PF 2 35 421

Model:

- With butt fusion spigot and taper male thread
- Connection to plastic thread only
- Do not use thread sealing pastes that are harmful to PVDF
- Avoid stresses when installing and large changes in temperature

d [mm]	NPT [inch]	PN	Code	kg	e [mm]	L [mm]	s [mm]	L1 [mm]
20	3/8	16	735 914 555	0.023	1.9	50	32	28
20	1/2	16	735 914 556	0.025	1.9	53	32	28
25	3/4	16	735 914 557	0.032	1.9	55	36	28
32	1	16	735 914 558	0.052	2.4	57	46	28
40	1 1/4	16	735 914 559	0.075	2.4	60	55	28
50	1 1/2	16	735 914 560	0.112	3.0	63	65	28
63	2	16	735 914 561	0.179	3.0	69	75	29

35 91 02

Adaptor Socket, female thread - Rp, PN16, PVDF-Standard **K**

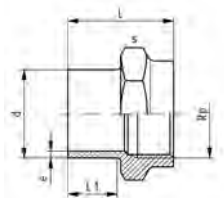

PF 2 35 421

Model:

- With butt fusion spigot and BSP parallel female thread
- Connection to plastic thread only
- Do not use thread sealing pastes that are harmful to PVDF
- Avoid stresses when installing and large changes in temperature

d [mm]	Rp [inch]	PN	Code	kg	e [mm]	L [mm]	s [mm]	L1 [mm]
20	3/8	16	735 910 265	0.030	1.9	49	32	23
20	1/2	16	735 910 266	0.026	1.9	49	32	23
25	3/4	16	735 910 267	0.032	1.9	51	36	23
32	1	16	735 910 268	0.058	2.4	54	46	23
40	1 1/4	16	735 910 269	0.079	2.4	56	55	23
50	1 1/2	16	735 910 270	0.100	3.0	60	65	24
63	2	16	735 910 271	0.001	3.0	62	75	23

35 91 42

Adaptor Socket, female thread - NPT, PN 16, PVDF-Standard

K

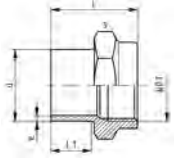

Model:

- With butt fusion spigot and taper female thread
- Connection to plastic thread only
- Do not use thread sealing pastes that are harmful to PVDF
- Avoid stresses when installing and large changes in temperature

d [mm]	NPT [inch]	PN	Code	kg	e [mm]	L [mm]	s [mm]	L1 [mm]
20	3/8	16	735 914 265	0.030	1.9	49	32	28
20	1/2	16	735 914 266	0.026	1.9	49	32	28
25	3/4	16	735 914 267	0.032	1.9	51	36	28
32	1	16	735 914 268	0.058	2.4	54	46	28
40	1 1/4	16	735 914 269	0.079	2.4	57	55	28
50	1 1/2	16	735 914 270	0.001	3.0	60	65	28
63	2	16	735 914 271	0.001	3.0	64	75	29

PF 2 35 421

35 96 86

Hose Adapter, PN 16, PVDF-Standard

K

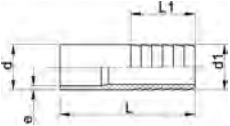

Model:

- With butt fusion spigot

d - d1 [mm]	PN	e [mm]	L [mm]	L1 [mm]	Code	kg
20 - 20	16	1.9	64	27	735 968 606	0.001
25 - 25	16	1.9	75	36	735 968 607	0.001
32 - 32	16	2.4	82	36	735 968 608	0.001
40 - 40	16	2.4	84	42	735 968 609	0.001
50 - 50	16	3.0	90	48	735 968 610	0.084
63 - 60	16	3.0	100	50	735 968 611	0.118

PF 2 35 421

Flange Adaptors, Flanges and Gaskets for Butt Fusion

35 79 88

Flange Adaptors, PN16, jointing face serrated, PVDF-Standard

K

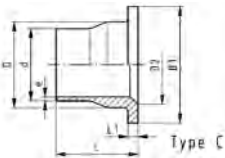
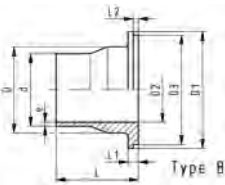
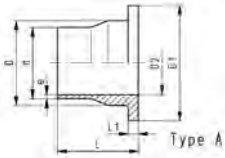

PF 2 35 190

d [mm]	DN [mm]	PN	Code	kg	D [mm]	D1 [mm]	D2 [mm]	D3 [mm]	e [mm]	L [mm]	L1 [mm]	L2 [mm]	Type
20	15	16	735 798 806	0.029	26	45	15		1.9	54	6		A
25	20	16	735 798 807	0.044	32	58	20	54	1.9	56	7	4	B
32	25	16	735 798 808	0.066	40	68	26	63	2.4	58	7	4	B
40	32	16	735 798 809	0.093	49	78	34	73	2.4	68	8	4	B
50	40	16	735 798 810	0.129	60	88	43	82	3.0	69	8	4	B
63	50	16	735 798 811	0.187	75	102	56		3.0	72	9		A
75	65	16	735 798 812	0.298	89	122	66		3.6	80	10		A
90	80	16	735 798 813	0.377	105	138	78	133	4.3	81	12	4	B
110	100	16	735 798 814	0.630	125	158	100		5.3	81	13		C
140	125	16	735 798 816	0.847	155	188	127		6.7	90	16		C
160	150	16	735 798 817	1.200	175	212	151		7.7	93	17		C
200	200	16	735 798 819	1.900	232	268	203		9.6	102	22		C
225	200	16	735 798 820	2.000	235	268	203		10.8	102	22		C

35 79 88

Flange Adaptors, PN16, inch ANSI jointing face serrated, PVDF-Standard

K

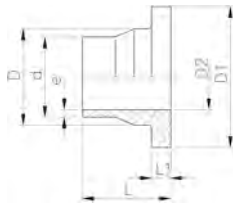

PF 2 35 190

Model:

- Other dimensions identical with metric version

d [mm]	d [inch]	PN	Code	kg	D [mm]	D1 [mm]	D2 [mm]	e [mm]	L [mm]	L1 [mm]	
25	¾	16	735 798 857	0.043	32	54	20	1.9	56	7	
32	1	16	735 798 858	0.063	40	63	26	2.4	58	7	
40	1 ¼	16	735 798 859	0.089	49	73	34	2.4	68	8	
50	1 ½	16	735 798 860	0.123	60	82	43	3.0	69	8	
90	3	16	735 798 861	0.362	105	133	78	4.3	81	12	

Flange Adaptors, PN10, jointing face serrated, PVDF-Standard

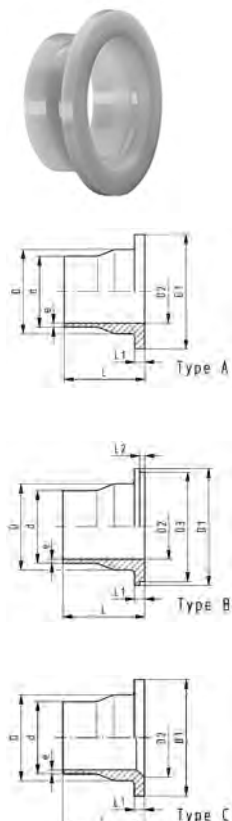

PF 2 35 190

d [mm]	DN [mm]	PN	Code	kg	D [mm]	D1 [mm]	D2 [mm]	D3 [mm]	e [mm]	L [mm]	L1 [mm]	L2 [mm]	Type
90	80	10	735 798 863	0.350	105	138	78	133	2.8	81	12	4	B
110	100	10	735 798 864	0.450	125	158	100		3.4	81	13		A
125	100	10	735 798 865	0.480	132	158	114		3.9	82	14		A
140	125	10	735 798 866	0.710	155	188	127		4.3	90	16		A
160	150	10	735 798 867	1.000	175	212	151		4.9	93	17		C
200	200	10	735 798 869	1.700	232	268	203		6.2	102	22		C
225	200	10	735 798 870	1.600	235	268	203		6.9	102	22		A

27 70 04
27 70 05

Backing Flanges, PP-V for Butt Fusion Systems metric

G

Model:

- Modern full-plastic flange PP-GF (30 % glass-fibre reinforced)
- With V-groove which applies force evenly on collar
- With integrated bolt retainers as an assembly aid
- Connecting dimension: ISO 7005 PN 10, EN 1092 PN 10, DIN 2501 PN 10, BS 4504 PN 10

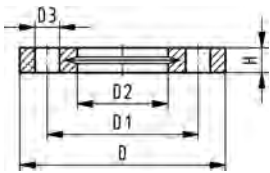

*) Suitable for socket- and butt fusion systems (no pictograph on flange)

d [mm]	Inch	DN [mm]	PN	Code	SP	kg	D [mm]	D1 [mm]	D2 [mm]	D3 [mm]	H [mm]	AL	SC
20		15	16	727 700 406	-	0.080	95	65	28	14	16	4	M12
25		20	16	727 700 407	-	0.100	105	75	34	14	17	4	M12
32		25	16	727 700 408	-	0.140	115	85	42	14	18	4	M12
40		32	16	727 700 409	-	0.220	140	100	51	18	20	4	M16
50		40	16	727 700 410	-	0.210	150	110	62	18	22	4	M16
63		50	16	727 700 411	-	0.380	165	125	78	18	24	4	M16
75		65	16	727 700 412	-	0.480	185	145	92	18	26	4	M16
90		80	16	727 700 513	-	0.520	200	160	108	18	27	8	M16
110		100	16	727 700 514	-	0.680	220	180	128	18	28	8	M16
125		100	16	727 700 515	-	0.760	220	180	135	18	28	8	M16
140		125	16	727 700 516	-	0.800	250	210	158	18	30	8	M16
160	6	150	16	727 700 517	-	1.200	285	241	178	22	32	8	M20
180		150	16	727 700 518	-	1.200	285	240	188	22	32	8	M20
200	8	200	16	727 700 519	-	1.400	340	295	235	22	34	8	M20
225	9	200	16	727 700 520	-	1.400	340	295	238	22	34	8	M20
250		250	16	727 700 521	-	1.700	395	350	288	22	38	12	M20
280		250	16	727 700 522	-	1.700	395	350	294	22	38	12	M20
315		300	16	727 700 523	-	2.400	445	400	338	22	42	12	M20

PF 2 34 238

27 70 02
27 70 03

Backing Flanges, PP/Steel for Butt Fusion Systems metric

G

Model:

- Material: PP (30 % glass-fibre reinforced) with steel ring
- Connecting dimensions: ISO 7005 / EN 1092 / DIN 2501 PN10 / BS4504

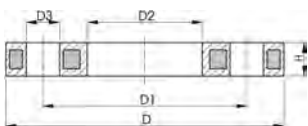

d [mm]	DN [mm]	PN	Code	D [mm]	D1 [mm]	D2 [mm]	D3 [mm]	H [mm]	AL	SC
20	15	16	727 700 206	95	65	28	14	12	4	M12
25	20	16	727 700 207	105	75	34	14	12	4	M12
32	25	16	727 700 208	115	85	42	14	16	4	M12
40	32	16	727 700 209	140	100	51	18	16	4	M16
50	40	16	727 700 210	150	110	62	18	18	4	M16
63	50	16	727 700 211	165	125	78	18	18	4	M16
75	65	16	727 700 212	185	145	92	18	18	4	M16
90	80	16	727 700 313	200	160	108	18	20	8	M16
110	100	16	727 700 314	220	180	128	18	20	8	M16
125	100	16	727 700 315	220	180	135	18	20	8	M16
140	125	16	727 700 316	250	210	158	18	24	8	M16
160	150	16	727 700 317	285	240	178	22	24	8	M20
180	150	16	727 700 318	285	240	188	22	24	8	M20
200	200	16	727 700 319	340	295	235	22	27	8	M20
225	200	16	727 700 320	340	295	238	22	27	8	M20
250	250	16	727 700 321	395	350	288	22	30	12	M20
280	250	16	727 700 322	395	350	294	22	30	12	M20
315	300	16	727 700 323	445	400	338	22	34	12	M20
355	350	16	727 700 324	515	460	376	23	40	16	M20
400	400	16	727 700 325	574	515	430	26	40	16	M24

PF 2 34 238

27 70 14
27 70 15

Backing Flanges, PP-V for Butt Fusion Systems Inch/ANSI

G

Model:

- Modern full-plastic flange PP-GF (30 % glass-fibre reinforced)
- With V-groove which applies force evenly on collar
- With integrated bolt-fixing as an assembly aid
- Connection dimensions according to ANSI B 16.5, ASTM D 4024; bolt circle class 150

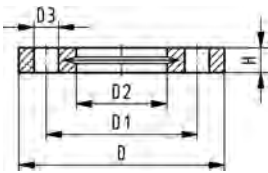
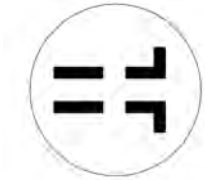

PF 2 34 238

¹⁾ Suitable for socket- and butt fusion systems (no pictograph on flange)

Inch	DN [mm]	PN	Code	kg	D [mm]	D1 [mm]	D2 [mm]	D3 [mm]	H [mm]	AL	SC
1/2	15	16	727 701 406	0.080	95	60	28	16	16	4	M12
3/4	20	16	727 701 407	0.100	105	70	34	16	17	4	M12
1	25	16	727 701 408	0.140	115	79	42	16	18	4	M12
1 1/4	32	16	727 701 409	0.220	140	89	51	16	20	4	M16
1 1/2	40	16	727 701 410	0.210	150	98	62	16	22	4	M16
2	50	16	727 701 411	0.380	165	121	78	19	24	4	M16
2 1/2	65	16	727 701 412	0.480	185	140	92	19	26	4	M16
3	80	16	727 701 513	0.520	200	152	108	19	27	4	M16
4	100	16	727 701 514	0.680	229	190	128	19	28	8	M16
6	150	16	727 700 517	1.200	285	241	178	22	32	8	M20
8	200	16	727 700 519	1.400	340	295	235	22	34	8	M20
9	200	16	727 700 520	1.400	340	295	238	22	34	8	M20
10	250	16	727 701 521	1.800	406	362	288	26	38	12	M20
10	250	16	727 701 522	1.700	406	362	294	26	38	12	M20
12	300	16	727 701 523	2.400	483	432	338	26	42	12	M20

27 70 12

Backing Flanges, PP/Steel for Butt Fusion Systems Inch/ANSI

G

Model:

- For butt fusion systems
- Material: PP (30 % glass-fibre reinforced) with steel ring
- Bolt circle diameter and bolt holes: ANSI B16.5

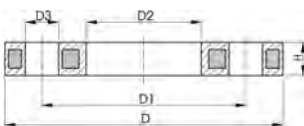
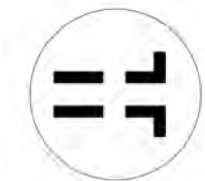

PF 2 34 238

Inch	DN [mm]	d [mm]	PN	Code	SP	kg	D [mm]	D1 [mm]	D2 [mm]	D3 [mm]	H [mm]	AL
1/2	15	20	16	727 701 206	-	0.210	95	60	28	16	12	4
3/4	20	25	16	727 701 207	-	0.250	105	70	34	16	12	4
1	25	32	16	727 701 208	-	0.420	115	79	42	16	16	4
1 1/4	32	40	16	727 701 209	-	0.670	140	89	51	16	16	4
1 1/2	40	50	16	727 701 210	-	0.860	150	98	62	16	18	4
2	50	63	16	727 701 211	-	0.930	165	121	78	19	18	4
2 1/2	65	75	16	727 701 212	-	1.340	185	140	92	19	18	4
3	80	90	16	727 701 313			200	152	108	19	20	4
4	100	110	16	727 701 314			229	190	128	19	20	8
6	150	160	16	727 701 317			285	241	178	22	24	8
(8)	200	200	16	727 701 319			340	298	235	22	27	8
8	200	225	16	727 701 320			340	298	238	22	27	8

SYGEF® Standard

Backing Flange PVDF/Steel for Butt Fusion Systems metric

Model:

- Material: PVDF (blue) coated steel
- Bolt circle diameter and bolt holes: ANSI B16.5 #150

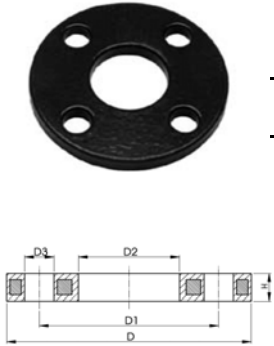

d	DN	Inch	Code	PN	KG	D (mm)	D1 (mm)	D2 (mm)	D3 (mm)	H (mm)	AL
20	15	¾	155 701 806	16	0.23	89	60	28	16	7	4
25	20	¾	155 701 807	16	0.34	98	70	34	16	7	4
32	25	1	155 701 808	16	0.34	108	79	42	16	7	4
40	32	1¼	155 701 809	16	0.51	117	89	51	16	8	4
50	40	1½	155 701 810	16	0.60	127	98	62	16	8	4
63	50	2	155 701 811	16	0.97	152	121	78	19	10	4
75	65	2½	155 701 812	16	1.34	178	140	92	19	10	4
90	80	3	155 701 813	16	1.45	190	152	110	19	10	4
110	100	4	155 701 814	16	2.07	229	190	133	19	10	8
160	150	6	155 701 917	16	3.34	279	241	179	22	13	8
200	200	8	155 701 919	16	5.96	343	298	236	22	16	8
225	200	8/9	155 701 920	16	5.75	343	298	239	22	16	8
250	225	10	155 701 921	10	7.62	406	362	288	22	22	12
315	300	12	155 701 923	10	18.18	483	432	338	25	25	12

SYGEF Plus Gasket

Model:

- TFM (tetrafluoroethylene) coated EPDM
- Self-centering design
- Multiple use gasket
- Specially cleaned & double-bagged
- Compatible with ANSI, ISO/DIN & JIS Flange Adaptors
- Must be used with Steel Backing Flange (not for use with PP-V Flange)

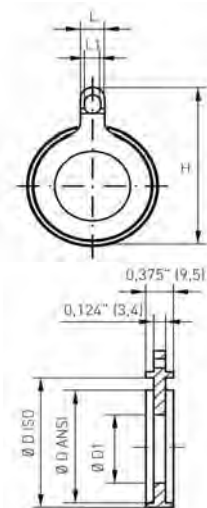

d	DN	Inch	Code	H	D ISO (mm)	D ANSI (inch)	L (mm)	L1 (mm)	D1 (mm)	Torque (Nm)
25	20	¾	731 400 753	76	58	2.13	20	13	23	9
32	25	1	731 400 755	91	68	2.48	25	16	30	10
40	32	1¼	731 400 757	101	78	2.87	25	16	38	20
50	40	1½	731 400 759	110	88	3.23	25	16	46	25
63	50	2	731 400 760	128	102	4.02	25	16	59	30
75	65	2½	731 400 761	148	122	4.80	25	16	67	35
90	80	3	731 400 763	161	138	5.24	25	16	80	40
110	100	4	731 400 764	189	158	6.22	25	16	98	45
140	125	5	731 400 666	219	188	7.40	30	20	129	50
160	150	6	731 400 667	244	212	8.35	30	20	148	60
200	200	8	731 400 669	300	268	10.55	30	20	185	75
225	200	8/9	731 400 670	300	268	10.55	30	20	209	75
250	225	10	731 400 671	369	320	12.60	35	22	250	80

EPDM 48 44 01
FPM 49 44 01

Flange Gaskets metric

A

Model:

- G-ST-P/K Profil
- Hardness: 70° Shore **EPDM**, 75° Shore **FPM**
- For Flange Adaptors
- For flange adaptors only in combination with butterfly valves



d [mm]	EPDM Code	FPM Code	kg	D [mm]	D1 [mm]	H [mm]	H1 [mm]
16	748 440 100	749 440 100	0.007	46	16	4	3
20	748 440 101	749 440 101	0.008	51	20	4	3
25	748 440 102	749 440 102	0.011	61	25	4	3
32	748 440 103	749 440 103	0.014	71	32	4	3
40	748 440 104	749 440 104	0.020	82	40	4	3
50	748 440 105	749 440 105	0.021	92	50	4	3
63	748 440 106	749 440 106	0.040	107	63	5	4
75	748 440 107	749 440 107	0.054	127	75	5	4
90	748 440 108	749 440 108	0.060	142	90	5	4
110	748 440 109	749 440 109	0.083	162	110	6	5
125	748 440 110	749 440 110	0.154	192	125	6	5
140	748 440 111	749 440 111	0.115	192	140	6	5
160	748 440 112	749 440 112	0.149	218	160	8	6
200	748 440 114	749 440 114	0.257	273	200	8	6
225	748 440 115	749 440 115	0.177	273	225	8	6
250	748 440 116	749 440 116	0.400	328	250	8	6
280	748 440 117	749 440 117	0.220	328	280	8	6
315	748 440 118	749 440 118	0.326	378	315	8	6
355	748 440 119	749 440 119	0.400	438	355	10	7
400	748 440 120	749 440 120	0.500	489	400	10	7

PF 2 30 162

Fittings for Socket Fusion

35 10 01

Elbow 90°, PN 16, PVDF-Standard

J

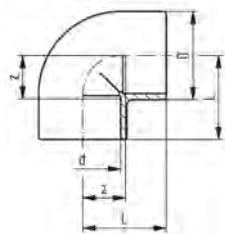

PF 2 35 189

d [mm]	PN	Code	kg	kg/m	D [mm]	L [mm]	z [mm]
16	16	735 100 105	0.029	0.029	26	25	12
20	16	735 100 106	0.026	0.026	27	28	14
25	16	735 100 107	0.038	0.038	32	32	16
32	16	735 100 108	0.065	0.065	40	38	20
40	16	735 100 109	0.104	0.104	49	44	24
50	16	735 100 110	0.164	0.164	60	51	28
63	16	735 100 111	0.284	0.284	75	62	35

35 15 01

Elbows 45° ; PN 16, PVDF-Standard

J



PF 2 35 189

d [mm]	PN	Code	kg	kg/m	D [mm]	L [mm]	z [mm]
16	16	735 150 105	0.017	0.017	23	20	7
20	16	735 150 106	0.020	0.020	27	21	7
25	16	735 150 107	0.030	0.030	32	24	8
32	16	735 150 108	0.051	0.051	40	28	10
40	16	735 150 109	0.083	0.083	49	33	13
50	16	735 150 110	0.123	0.123	60	36	13
63	16	735 150 111	0.211	0.211	75	43	16

35 20 01

T 90° equal ; PN 16, PVDF-Standard

J

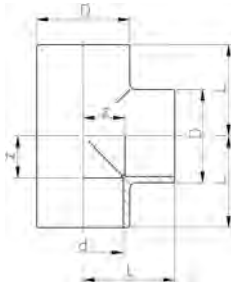

PF 2 35 189

d [mm]	PN	Code	kg	kg/m	D [mm]	L [mm]	z [mm]
16	16	735 200 105	0.039	0.039	26	25	12
20	16	735 200 106	0.035	0.035	27	28	14
25	16	735 200 107	0.050	0.050	32	32	16
32	16	735 200 108	0.085	0.085	40	38	20
40	16	735 200 109	0.135	0.135	49	44	24
50	16	735 200 110	0.208	0.208	60	51	28
63	16	735 200 111	0.360	0.360	75	62	35

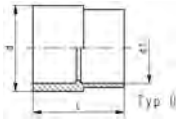
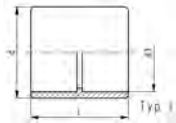
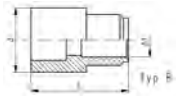
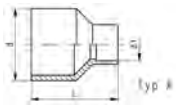

d - d1 [mm]	PN	Code	kg	kg/m	L [mm]	z [mm]	Type
20 - 16	16	735 910 334	0.017	0.017	35	22	B
25 - 20	16	735 910 337	0.017	0.017	37	23	A
32 - 20	16	735 910 342	0.022	0.022	43	29	A
32 - 25	16	735 910 341	0.023	0.023	39	23	C
40 - 20	16	735 910 348	0.033	0.033	48	34	A
40 - 25	16	735 910 347	0.037	0.037	48	32	A
40 - 32	16	735 910 346	0.037	0.037	43	25	C
50 - 20	16	735 910 355	0.059	0.059	54	40	A
50 - 25	16	735 910 354	0.058	0.058	54	38	A
50 - 32	16	735 910 353	0.062	0.062	54	36	A
50 - 40	16	735 910 352	0.063	0.063	48	28	C
63 - 20	16	735 910 362	0.103	0.103	64	50	A
63 - 25	16	735 910 361	0.105	0.105	64	48	A
63 - 32	16	735 910 360	0.108	0.108	64	46	A
63 - 40	16	735 910 359	0.117	0.117	64	44	A
63 - 50	16	735 910 358	0.105	0.105	54	31	D

Overview about functionality

Code	PN	L	Main function			Additional functions												
			Reduction Spigot - Socket			Reduction Socket - Socket			Reduction Spigot - Spigot			Reduktion Socket - Spigot						
			Spigot d	Socket d ₁	L	Z	Socket d	Socket d ₁	L	Z	Spigot d	Spigot d ₁	L	Z	Socket d	Spigot d ₁	L	Z
735 910 334	16	35	20	16	35	22												
735 910 337	16	37	25	20	37	23												
735 910 342	16	43	32	20	43	29	25	20	43	13								
735 910 341	16	39	32	25	39	23												
735 910 348	16	48	40	20	48	34	32	20	48	16								
735 910 347	16	48	40	25	48	32	32	25	48	14	40	32	48	48				
735 910 346	16	43	40	32	43	25												
735 910 355	16	54	50	20	54	40	40	20	54	20								
735 910 354	16	54	50	25	54	38	40	25	54	18	50	32	54	54	40	32	54	34
735 910 353	16	54	50	32	54	36	40	32	54	16	50	40	54	54				
735 910 352	16	48	50	40	48	28												
735 910 362	16	64	63	20	64	50	50	20	64	27								
735 910 361	16	64	63	25	64	48	50	25	64	25	63	32	64	64	50	32	64	41
735 910 360	16	64	63	32	64	46	50	32	64	23	63	40	64	64	50	40	64	41
735 910 359	16	64	63	40	64	44	50	40	64	21	63	50	64	64				
735 910 358	16	54	63	50	54	31												

Please note: Illustration of the functions not inevitably conform to respective type!

35 91 01

Socket equal, PN16, PVDF-Standard

J

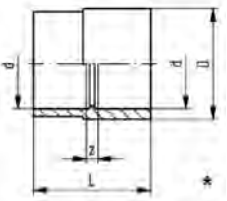
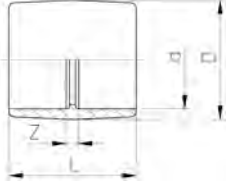

PF 2 35 189

d [mm]	PN	Code	kg	kg/m	D [mm]	L [mm]	z [mm]
16	16	735 910 105	0.020	0.020	26	33	7
20	16	735 910 106	0.016	0.016	27	35	7
25	16	735 910 107	0.023	0.023	32	39	7
32	16	735 910 108	0.037	0.037	40	43	7
*40	16	735 910 109	0.063	0.063	50	48	8
*50	16	735 910 110	0.105	0.105	63	54	8
63	16	735 910 111	0.146	0.146	75	62	8

35 96 01

Caps ; PN 16, PVDF-Standard

J

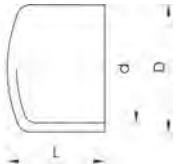

PF 2 35 189

d [mm]	PN	Code	kg	kg/m	D [mm]	L [mm]
16	16	735 960 105	0.013	0.013	25	24
20	16	735 960 106	0.011	0.011	27	23
25	16	735 960 107	0.017	0.017	32	26
32	16	735 960 108	0.028	0.028	40	30
40	16	735 960 109	0.045	0.045	49	34
50	16	735 960 110	0.073	0.073	60	39
63	16	735 960 111	0.128	0.128	75	46

Unions for Socket Fusion

35 51 01

Union (FPM black), PN16, PVDF-Standard

J

- Supplied with: O-Ring No. 49 41 00 FPM (e.g. Viton A®)
- Please see installation instruction



PF 2 35 191

d [mm]	PN	Code	GP	kg	kg/m	D [mm]	G [inch]	L1 [mm]	L2 [mm]	z1 [mm]	z [mm]	
16	16	735 510 105	140	0.025	0.025	35	3/4	18	24	5	11	
20	16	735 510 106	70	0.064	0.064	45	1	19	26	5	12	
25	16	735 510 107	50	0.101	0.101	55	1 1/4	21	28	5	12	
32	16	735 510 108	20	0.132	0.132	62	1 1/2	23	30	5	12	
40	16	735 510 109	20	0.219	0.219	75	2	25	34	5	14	
50	16	735 510 110	30	0.289	0.289	84	2 1/4	28	39	5	16	
63	16	735 510 111	12	0.496	0.496	101	2 3/4	32	47	5	20	

35 60 01

Union end, PN 16, PVDF-Standard

J

Model:

- Suitable for SYGEF® Standard Union Socket Fusion
- Suitable for Diaphragm Valve Type 314
- Suitable for Vortex Sensor



PF 2 35 191

d [mm]	PN	Code	kg	kg/m	D [mm]	D1 [mm]	L [mm]	L1 [mm]	z [mm]	
16	16	735 600 105	0.006	0.006	24	22	18	4	5	
20	16	735 600 106	0.011	0.011	30	28	19	5	5	
25	16	735 600 107	0.022	0.022	39	36	21	5	5	
32	16	735 600 108	0.026	0.026	45	42	23	6	5	
40	16	735 600 109	0.046	0.046	57	53	25	6	5	
50	16	735 600 110	0.054	0.054	63	59	28	7	5	
63	16	735 600 111	0.079	0.079	78	74	32	7	5	

Blanking Union End

d [mm]	d [inch]	PN	DN [mm]	Code	SP	GP	kg	kg/m	A [mm]	B [mm]	C [inch]	D [mm]	
20		232	0	175 482 101	-	-	0.007	0.007					
25		232	0	175 482 102	-	-	0.015	0.015	1	1	1	0	
32		232	0	175 482 103	-	-	0.025	0.025	2	1	1	0	
50		232	0	175 482 105	-	-	0.060	0.060					
63		232	0	175 482 106	-	-	0.110	0.110					

PF 2 65 434

24 60 07

Union Ends, Stainless Steel 1.4404 (316L)**R****A**

PF 2 30 153

Model:

- Taper male thread R

R [inch]	PN	Code	SP	GP	kg	D [mm]	D1 [mm]	L [mm]	s [mm]	
3/8	16	724 600 705	-	-	0.050	24	22	30	19	
1/2	16	724 600 706	-	-	0.090	30	28	34	24	
3/4	16	724 600 707	-	-	0.120	39	36	36	32	
1	16	724 600 708	-	-	0.190	45	42	40	37	
1 1/4	16	724 600 709	-	-	0.350	57	53	46	48	
1 1/2	16	724 600 710	-	-	0.400	63	59	48	54	
2	16	724 600 711	-	-	0.660	78	74	55	69	

24 60 06

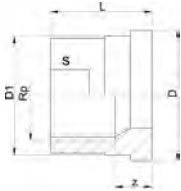
Union Ends, Stainless Steel 1.4404 (316L)**Rp****A**

PF 2 30 153

Model:

- Parallel female thread Rp

Rp [inch]	PN	Code	SP	GP	kg	z [mm]	D [mm]	D1 [mm]	L [mm]	s [mm]	
3/8	16	724 600 655	-	-	0.030	9	24	22	19	19	
1/2	16	724 600 656	-	-	0.060	11	30	28	24	24	
3/4	16	724 600 657	-	-	0.100	11	39	36	26	29	
1	16	724 600 658	-	-	0.140	12	45	42	29	36	
1 1/4	16	724 600 659	-	-	0.230	14	57	53	33	45	
1 1/2	16	724 600 660	-	-	0.320	15	63	59	34	54	
2	16	724 600 661	-	-	0.450	15	78	74	39	63	

24 60 55

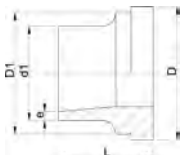
Union Ends, Stainless Steel 1.4404 (316L)**Welding End****A**

PF 2 30 153

d [mm]	d1 [mm]	PN	Code	SP	GP	kg	D [mm]	D1 [mm]	L [mm]	e [mm]	
16	17	16	724 605 505	-	-	0.030	24	22	18	1.6	
20	21	16	724 605 506	-	-	0.050	30	28	22	2.0	
25	26	16	724 605 507	-	-	0.080	39	36	23	2.0	
32	33	16	724 605 508	-	-	0.110	45	42	26	2.0	
40	42	16	724 605 509	-	-	0.190	57	53	26	2.0	
50	48	16	724 605 510	-	-	0.220	63	59	28	2.0	
63	60	16	724 605 511	-	-	0.370	78	74	32	2.6	

35 69 04

Union nut, PN16, PVDF-Standard

J

- d75, d90 and d110 with buttress shaped thread

Note:

- For the dimensions d75-110 please see instructions for the installation



PF 2 35 191

Socket Fusion d [mm]	Butt Fusion d [mm]	PN	Code	kg	kg/m	D [mm]	G [inch]	L [mm]	
16	16	16	735 690 405	0.013	0.013	35	3/4	21	
20	20	16	735 690 406	0.023	0.023	45	1	22	
25	25	16	735 690 407	0.047	0.047	55	1 1/4	24	
32	32	16	735 690 408	0.048	0.048	62	1 1/2	26	
40	40	16	735 690 409	0.097	0.097	75	2	29	
50	50	16	735 690 410	0.146	0.146	84	2 1/4	33	
63	63	16	735 690 411	0.244	0.244	101	2 3/4	35	

24 69 01

Union nut stainless steel 1.4404 (316L)

A

* Octagon union nut

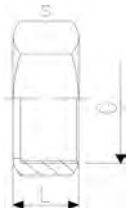

PF 2 30 153

d [mm]	PN	Code	SP	GP	kg	kg/m	L [mm]	G [inch]	s [mm]	
16	16	724 690 105	-	-	0.060	0.060	19	¾	32	
20	16	724 690 106	-	-	0.110	0.110	21	1	41	
25	16	724 690 107	-	-	0.100	0.100	23	1 ¼	46	
32	16	724 690 108	-	-	0.170	0.170	24	1 ½	55	
*40	16	724 690 109	-	-	0.240	0.240	27	2	68	
*50	16	724 690 110	-	-	0.300	0.300	31	2 ¼	74	
*63	16	724 690 111	-	-	0.390	0.390	35	2 ¾	88	

35 64 01

Union bush, PN 16, PVDF-Standard

J

Model:

- Suitable for SYGEF® Standard Union Socket Fusion



PF 2 35 191

d [mm]	PN	Code	kg	kg/m	G [inch]	L [mm]	z [mm]	
16	16	735 640 105	0.011	0.011	3/4	24	11	
20	16	735 640 106	0.019	0.019	1	26	12	
25	16	735 640 107	0.031	0.031	1 1/4	28	12	
32	16	735 640 108	0.042	0.042	1 1/2	30	12	
40	16	735 640 109	0.069	0.069	2	34	14	
50	16	735 640 110	0.091	0.091	2 1/4	39	16	
63	16	735 640 111	0.161	0.161	2 3/4	47	20	

EPDM 48 41 00
FPM 49 41 00

O-Ring Gaskets

A

Model:

- For unions
- Hardness approx. 65° Shore
- EPDM minimum temperature -40°C
- FPM minimum temperature -15°C

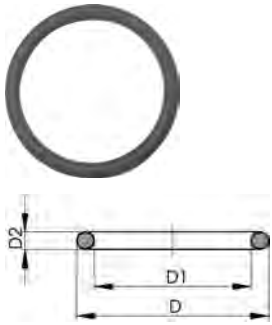

d [mm]	DN [mm]	EPDM Code	FPM Code	SP	GP	kg	kg/m	D [mm]	D1 [mm]	D2 [mm]
10-12	8	748 410 004	749 410 004	-	-	0.002	0.002	18	12	3
16	10	748 410 005	749 410 005	-	-	0.002	0.002	21	16	3
20	15	748 410 006	749 410 006	-	-	0.002	0.002	27	20	4
25	20	748 410 007	749 410 007	100	1400	0.002	0.002	35	28	4
32	25	748 410 008	749 410 008	100	-	0.002	0.002	40	33	4
40	32	748 410 009	749 410 009	-	-	0.006	0.006	51	41	5
50	40	748 410 010	749 410 010	-	-	0.007	0.007	58	47	5
63	50	748 410 011	749 410 011	100	3500	0.010	0.010	70	60	5
75	65	748 410 014	749 410 014	100	600	0.012	0.012	93	82	5
90	80	748 410 015	749 410 015	100	600	0.015	0.015	112	101	5
110	100	748 410 016	749 410 016	50	200	0.031	0.031	134	120	7

PF 2 30 162

O-Ring Gaskets

Model:

- For unions
- Hardness approx. 75° Shore
- FFPM minimum temperature -20°C

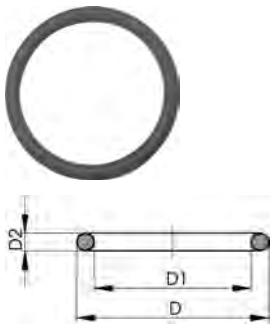

d [mm]	DN [mm]	FFPM Code	D [mm]	D1 [mm]	D2 [mm]
20	15	700 245 481	27	20	4
25	20	700 245 482	35	28	4
32	25	700 245 483	40	33	4
40	32	700 245 484	51	41	5
50	40	700 245 485	58	47	5
63	50	700 245 486	70	60	5

PF 2 30 1

Transition Fittings for Socket Fusion

35 91 02

Adaptor Socket, female thread - Rp, PN 16, PVDF-Standard

J

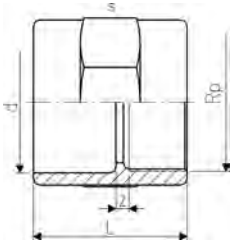

PF 2 35 191

Model:

- With socket fusion end and parallel female thread
- Connection to plastic thread only
- Do not use thread sealing pastes that are harmful to PVDF
- Avoid stresses when installing and large changes in temperature

d [mm]	Rp [inch]	PN	Code	kg	kg/m	L [mm]	s [mm]	z [mm]
20	½	16	735 910 206	0.030	0.030	34	32	5
25	¾	16	735 910 207	0.037	0.037	38	36	6
32	1	16	735 910 208	0.067	0.067	43	46	7
40	1 ¼	16	735 910 209	0.100	0.100	47	55	7
50	1 ½	16	735 910 210	0.135	0.135	54	65	9
63	2	16	735 910 211	0.217	0.217	62	80	9

35 91 42

Adaptor Socket, female thread - NPT, PN 16, PVDF-Standard

J

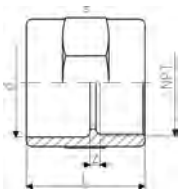

PF 2 35 191

Model:

- With socket fusion end and taper female thread
- Connection to plastic thread only
- Do not use thread sealing pastes that are harmful to PVDF
- Avoid stresses when installing and large changes in temperature

d [mm]	NPT [inch]	PN	Code	kg	kg/m	L [mm]	s [mm]	z [mm]
16	¾	16	735 914 205	0.016	0.016	29	27	3
20	½	16	735 914 206	0.030	0.030	34	32	5
25	¾	16	735 914 207	0.036	0.036	38	36	6
32	1	16	735 914 208	0.067	0.067	43	46	7
40	1 ¼	16	735 914 209	0.100	0.100	47	55	7
50	1 ½	16	735 914 210	0.140	0.140	54	65	9
63	2	16	735 914 211	0.220	0.220	62	80	9

35 91 05

Adaptor Nipple, male thread - R, PN 16, PVDF-Standard

J

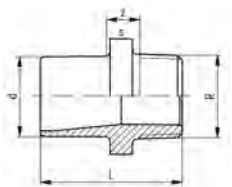

PF 2 35 191

Model:

- With socket fusion spigot metric and BSP tapered male thread
- Connection to plastic thread only
- Do not use thread sealing pastes that are harmful to PVDF
- Avoid stresses when installing and large changes in temperature

d [mm]	R [inch]	PN	Code	kg	kg/m	L [mm]	s [mm]	z [mm]
16	¾	16	735 910 505	0.015	0.015	37	27	12
20	½	16	735 910 506	0.025	0.025	53	32	25
25	¾	16	735 910 507	0.032	0.032	55	36	24
32	1	16	735 910 508	0.052	0.052	57	46	22
40	1 ¼	16	735 910 509	0.076	0.076	60	55	21
50	1 ½	16	735 910 510	0.112	0.112	63	65	19
63	2	16	735 910 511	0.163	0.163	69	75	18

35 91 45

Adaptor Nipple, male thread - NPT, PN 16, PVDF-Standard

J

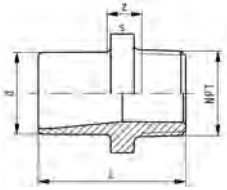

Model:

- With socket fusion spigot and taper male thread
- Connection to plastic thread only
- Do not use thread sealing pastes that are harmful to PVDF
- Avoid stresses when installing and large changes in temperature

d [mm]	NPT [inch]	PN	Code	kg	kg/m	L [mm]	s [mm]	z [mm]
16	3/8	16	735 914 505	0.014	0.014	37	27	12
20	1/2	16	735 914 506	0.025	0.025	53	32	25
25	3/4	16	735 914 507	0.033	0.033	55	36	24
32	1	16	735 914 508	0.052	0.052	57	46	22
40	1 1/4	16	735 914 509	0.076	0.076	60	55	21
50	1 1/2	16	735 914 510	0.114	0.114	63	65	19
63	2	16	735 914 511	0.164	0.164	69	75	18

PF 2 35 191

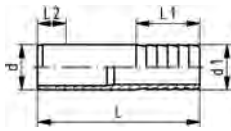

Hose Adapter, PN 16, PVDF-Standard

J

Model:

- With socket fusion spigot, PN 16

d - d1 [mm]	PN	Code	kg	kg/m	L [mm]	L1 [mm]	L2 [mm]	z [mm]
16 - 16	16	735 960 405	0.001	0.001	50	27	13	10
20 - 20	16	735 960 406	0.001	0.001	78	27	14	37
25 - 25	16	735 960 407	0.001	0.001	91	36	16	39
32 - 32	16	735 960 408	0.001	0.001	100	36	18	46
40 - 40	16	735 960 409	0.001	0.001	104	42	20	42
50 - 50	16	735 960 410	0.089	0.089	90	48	23	19
63 - 60	16	735 960 411	0.126	0.126	100	50	27	23

PF 2 35 191

Flange Adaptors, Flanges and Gaskets for Socket Fusion

Fixed Flanges, socket fusion Jointing face serrated, metric

J

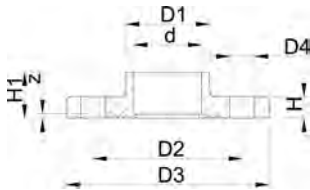

Model:

- With fusion socket metric
- Material: PVDF
- Flange drillings to: ISO / DIN

d [mm]	DN [mm]	Inch	PN	Code	SP	GP	kg	kg/m
20	15	1/2	16	735 740 106	-	-	0.137	0.137
25	20	3/4	16	735 740 107	-	-	0.185	0.185
32	25	1	16	735 740 108	-	-	0.255	0.255
40	32	1 1/4	16	735 740 109	-	-	0.402	0.402
50	40	1 1/2	16	735 740 110	-	-	0.486	0.486
63	50	2	16	735 740 111	-	-	0.551	0.551

d [mm]	D1 [mm]	D2 [mm]	D3 [mm]	D4 [mm]	H [mm]	H1 [mm]	AL	z [mm]
20	27	65	93	14	12	19	4	5
25	33	75	103	14	13	21	4	4
32	40	85	115	14	14	23	4	4
40	50	100	137	18	15	25	4	4
50	61	110	147	18	16	27	4	4
63	76	125	162	18	18	31	4	4

PF 2 35 446

Fixed Flanges, socket fusion Jointing face flat, metric

J

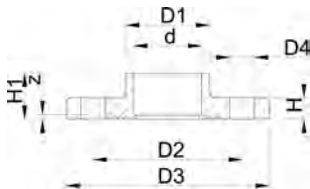

Model:

- With fusion socket metric
- Material: PVDF
- Flange drillings to: ISO / DIN

d [mm]	DN [mm]	Inch	PN	Code	SP	GP	kg	kg/m
20	15	11/2	16	735 730 106	-	-	0.137	0.137
25	20	13/4	16	735 730 107	-	-	0.185	0.185
32	25	1	16	735 730 108	-	-	0.255	0.255
40	32	1 1/4	16	735 730 109	-	-	0.355	0.355
50	40	1 1/2	16	735 730 110	-	-	0.486	0.486
63	50	2	16	735 730 111	-	-	0.653	0.653

d [mm]	D1 [mm]	D2 [mm]	D3 [mm]	D4 [mm]	H [mm]	H1 [mm]	AL	z [mm]
20	27	65	93	14	12	19	4	5
25	33	75	103	14	13	21	4	5
32	40	85	115	14	14	23	4	5
40	50	100	137	18	15	25	4	5
50	61	110	147	18	16	27	4	5
63	76	125	162	18	18	31	4	5

PF 2 35 446

Flange Adaptors with groove, PN 16, PVDF-Standard

J

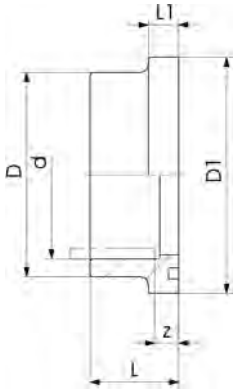

PF 2 35 191

Model:

- Jointing face: with O-ring groove
- Counterpart: Flange Adaptor metric or ANSI
- Gasket: O-ring EPDM No. 48 41 01, FPM No. 49 41 01

d [mm]	PN	Code	kg	kg/m	D [mm]	D1 [mm]	L [mm]	L1 [mm]	z [mm]
20	16	735 810 106	0.015	0.015	27	34	22	9	8
25	16	735 810 107	0.022	0.022	33	41	24	10	8
32	16	735 810 108	0.036	0.036	41	50	26	10	8
40	16	735 810 109	0.055	0.055	50	61	30	13	10
50	16	735 810 110	0.080	0.080	61	73	33	13	10
63	16	735 810 111	0.138	0.138	76	90	37	14	10

Flange Adaptor metric ; PN 16, PVDF-Standard

J



PF 2 35 191

Model:

- Increased face dimension metric
- Suitable for Flange Adaptor with groove
- Gasket: Profile Flange Gaskets **FPM** or **EPDM**
- Gasket: Flat Gasket **FPM** or **EPDM**

d [mm]	DN [mm]	PN	Code	kg	kg/m	D [mm]	D1 [mm]	L [mm]	L1 [mm]	z [mm]
20	15	16	735 790 206	0.020	0.020	27	45	19	6	3
25	20	16	735 790 207	0.037	0.037	33	58	21	7	3
32	25	16	735 790 208	0.051	0.051	41	68	23	7	3
40	32	16	735 790 209	0.073	0.073	50	78	25	8	3
50	40	16	735 790 210	0.095	0.095	61	88	28	8	3
63	50	16	735 790 211	0.142	0.142	76	102	32	9	3

Flange Adaptor, PN16, serrated, ANSI, PVDF-Standard

J



PF 2 35 191

Model:

- Suitable for Flange Adaptor with groove
- Face dimension ANSI
- Gasket: Flat Gasket **FPM** or **EPDM**
- Gasket: Profile Flange Gaskets **FPM** or **EPDM**
- Dimensions d20 and d63 are identical to metric version

d [mm]	d [inch]	PN	Code	GP	kg	kg/m	D [mm]	D1 [mm]	L [mm]	L1 [mm]	z [mm]
25	¾	16	735 790 257	-	0.037	0.037	33	54	21	7	3
32	1	16	735 790 258	-	0.051	0.051	41	63	23	7	3
40	1 ¼	16	735 790 259	-	0.073	0.073	50	73	25	8	3
50	1 ½	16	735 790 260	-	0.095	0.095	61	82	28	8	3

27 70 04
27 70 05

Backing Flanges, PP-V for Socket Systems metric

G

Model:

- Modern full-plastic flange PP-GF (30 % glass-fibre reinforced)
- With V-groove which applies force evenly on collar
- With integrated bolt retainers as an assembly aid
- Connecting dimension: ISO 7005 PN 10, EN 1092 PN 10, DIN 2501 PN 10, BS 4504 PN 10

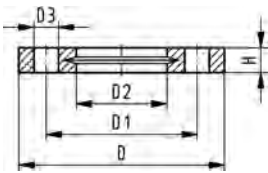

PF 2 34 238

¹⁾ Suitable for socket- and butt fusion systems (no pictograph on flange)

d [mm]	Inch	DN [mm]	PN	Code	kg	kg/m	D [mm]	D1 [mm]	D2 [mm]	D3 [mm]	H [mm]	AL	SC
'20		15	16	727 700 406	0.080	0.080	95	65	28	14	16	4	M12
'25		20	16	727 700 407	0.100	0.100	105	75	34	14	17	4	M12
'32		25	16	727 700 408	0.140	0.140	115	85	42	14	18	4	M12
'40		32	16	727 700 409	0.220	0.220	140	100	51	18	20	4	M16
'50		40	16	727 700 410	0.210	0.210	150	110	62	18	22	4	M16
'63		50	16	727 700 411	0.380	0.380	165	125	78	18	24	4	M16

27 70 02

Backing Flanges, PP/Steel for Socket Systems metric

G

Model:

- PP-GF (30% glass-fibre reinforced) with steel ring
- Connecting dimensions: ISO 7005, EN 1092, BS 4504, DIN 2501; bolt circle PN 10

* Connecting dimension: ISO 2536

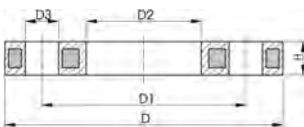

PF 2 34 238

d [mm]	DN [mm]	PN	Code	D [mm]	D1 [mm]	D2 [mm]	D3 [mm]	H [mm]	AL	SC
20	15	16	727 700 206	95	65	28	14	12	4	M12
25	20	16	727 700 207	105	75	34	14	12	4	M12
32	25	16	727 700 208	115	85	42	14	16	4	M12
40	32	16	727 700 209	140	100	51	18	16	4	M16
50	40	16	727 700 210	150	110	62	18	18	4	M16
63	50	16	727 700 211	165	125	78	18	18	4	M16

27 70 14
27 70 15

Backing Flanges, PP-V for Socket Systems Inch/ANSI

G

Model:

- Modern full-plastic flange PP-GF (30 % glass-fibre reinforced)
- With V-groove which applies force evenly on collar
- With integrated bolt-fixing as an assembly aid
- Connection dimensions according to ANSI B 16.5, ASTM D 4024; bolt circle class 150

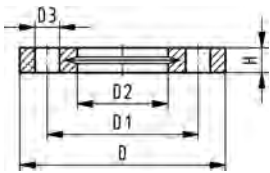
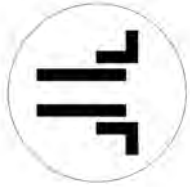

PF 2 34 238

¹⁾ Suitable for socket- and butt fusion systems (no pictograph on flange)

Inch	DN [mm]	PN	Code	kg	kg/m	D [mm]	D1 [mm]	D2 [mm]	D3 [mm]	H [mm]	AL	SC
1/2	15	16	727 701 406	0.080	0.080	95	60	28	16	16	4	M12
3/4	20	16	727 701 407	0.100	0.100	105	70	34	16	17	4	M12
1	25	16	727 701 408	0.140	0.140	115	79	42	16	18	4	M12
1 1/4	32	16	727 701 409	0.220	0.220	140	89	51	16	20	4	M16
1 1/2	40	16	727 701 410	0.210	0.210	150	98	62	16	22	4	M16
2	50	16	727 701 411	0.380	0.380	165	121	78	19	24	4	M16

27 70 12

Backing Flanges, PP/Steel for Socket Systems Inch/ANSI

G

Model:

- For socket systems
- For Flange Adaptors BS (ANSI)
- Material: PP (30 % glass-fibre reinforced) with steel ring
- Connecting dimension ANSI B 16.5 / ASTM D 4024
- DN100 and DN150: only for use with original metric flange adaptors

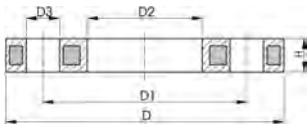

PF 2 34 238

Inch	DN [mm]	d [mm]	PN	Code	GP	kg	kg/m	D [mm]	D1 [mm]	D2 [mm]	D3 [mm]	H [mm]	AL
1/2	15	20	16	727 701 206	72	0.210	0.210	95	60	28	16	12	4
3/4	20	25	16	727 701 207	45	0.250	0.250	105	70	34	16	12	4
1	25	32	16	727 701 208	34	0.420	0.420	115	79	42	16	16	4
1 1/4	32	40	16	727 701 209	20	0.670	0.670	140	89	51	16	16	4
1 1/2	40	50	16	727 701 210	17	0.860	0.860	150	98	62	16	18	4
2	50	63	16	727 701 211	15	0.930	0.930	165	121	78	19	18	4

SYGEF® Standard

Backing Flange PVDF/Steel for Socket Fusion Systems metric

Model:

- Material: PVDF (blue) coated steel
- Bolt circle diameter and bolt holes: ANSI B16.5 #150

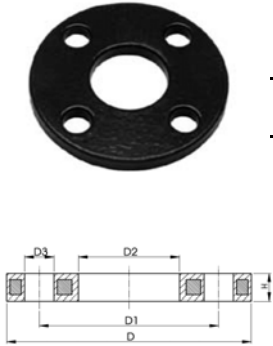

d	DN	Inch	Code	PN	KG	D (mm)	D1 (mm)	D2 (mm)	D3 (mm)	H (mm)	AL
20	15	¾	155 701 806	16	0.23	89	60	28	16	7	4
25	20	¾	155 701 807	16	0.34	98	70	34	16	7	4
32	25	1	155 701 808	16	0.34	108	79	42	16	7	4
40	32	1¼	155 701 809	16	0.51	117	89	51	16	8	4
50	40	1½	155 701 810	16	0.60	127	98	62	16	8	4
63	50	2	155 701 811	16	0.97	152	121	78	19	10	4
75	65	2½	155 701 812	16	1.34	178	140	92	19	10	4
90	80	3	155 701 813	16	1.45	190	152	110	19	10	4
110	100	4	155 701 814	16	2.07	229	190	133	19	10	8

SYGEF Plus Gasket

Model:

- TFM (tetrafluoroethylene) coated EPDM
- Self-centering design
- Multiple use gasket
- Specially cleaned & double-bagged
- Compatible with ANSI, ISO/DIN & JIS Flange Adaptors
- Must be used with Steel Backing Flange (not for use with PP-V Flange)

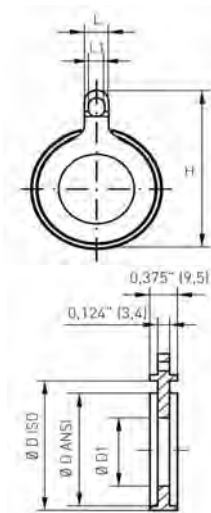

d	DN	Inch	Code	H	D ISO (mm)	D ANSI (inch)	L (mm)	L1 (mm)	D1 (mm)	Torque (Nm)
25	20	¾	731 400 753	76	58	2.13	20	13	23	9
32	25	1	731 400 755	91	68	2.48	25	16	30	10
40	32	1¼	731 400 757	101	78	2.87	25	16	38	20
50	40	1½	731 400 759	110	88	3.23	25	16	46	25
63	50	2	731 400 760	128	102	4.02	25	16	59	30
75	65	2½	731 400 761	148	122	4.80	25	16	67	35
90	80	3	731 400 763	161	138	5.24	25	16	80	40
110	100	4	731 400 764	189	158	6.22	25	16	98	45

EPDM 48 44 01
FPM 49 44 01

Flange Gaskets metric

A

Model:

- G-ST-P/K Profil
- Hardness: 70° Shore **EPDM**, 75° Shore **FPM**
- For Flange Adaptors
- For flange adaptors only in combination with butterfly valves



PF 2 30 162

d [mm]	EPDM Code	FPM Code	kg	kg/m	D [mm]	D1 [mm]	H [mm]	H1 [mm]	
16	748 440 100	749 440 100	0.007	0.007	46	16	4	3	
20	748 440 101	749 440 101	0.008	0.008	51	20	4	3	
25	748 440 102	749 440 102	0.011	0.011	61	25	4	3	
32	748 440 103	749 440 103	0.014	0.014	71	32	4	3	
40	748 440 104	749 440 104	0.020	0.020	82	40	4	3	
50	748 440 105	749 440 105	0.021	0.021	92	50	4	3	
63	748 440 106	749 440 106	0.040	0.040	107	63	5	4	

EPDM 48 41 01
FPM 49 41 01

O-Ring Gaskets

A

Model:

- For Flange Adaptors
- Hardness approx. 65° Shore

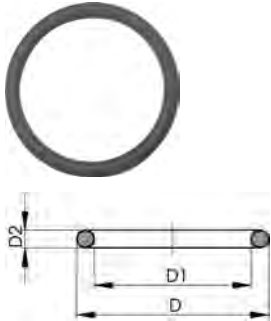

PF 2 31 800

d [mm]	DN [mm]	EPDM Code	FPM Code	SP	GP	kg	kg/m	D [mm]	D1 [mm]	D2 [mm]	
16	10	748 410 000	749 410 000	-	-	0.002	0.002	26	19	4	
20	15	748 410 001	749 410 001	100	-	0.002	0.002	31	23	4	
25	20	748 410 007	749 410 007	100	1400	0.002	0.002	35	28	4	
32	25	748 410 002	749 410 002	100	-	0.003	0.003	43	36	4	
40	32	748 410 003	749 410 003	-	-	0.007	0.007	55	44	5	
50	40	748 410 012	749 410 012	100	1000	0.008	0.008	64	53	5	
63	50	748 410 013	749 410 013	100	600	0.011	0.011	80	69	5	